



JCS620T

主要参数 MAIN CHARACTERISTICS

ID	5A
VDSS	200 V
Rdson-max (@Vgs=10V)	0.8Ω
Qg-typ	7.39nC

用途

- 高频开关电源
- 电子镇流器
- UPS 电源

产品特性

- 低栅极电荷
- 低 C_{rss}
- 开关速度快
- 产品全部经过雪崩测试
- 高抗 dv/dt 能力
- RoHS 产品

APPLICATIONS

- High efficiency switch mode power supplies
- Electronic lamp ballasts based on half bridge
- UPS

FEATURES

- Low gate charge
- Low C_{rss}
- Fast switching
- 100% avalanche tested
- Improved dv/dt capability
- RoHS product

封装 Package

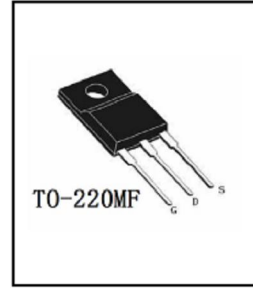
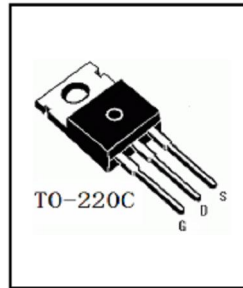
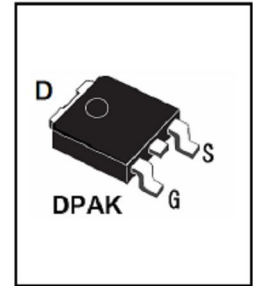
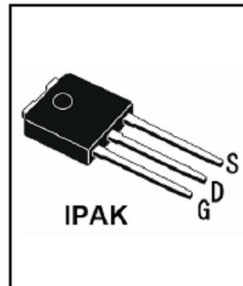
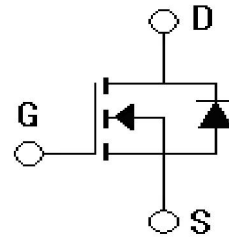

订货信息 ORDER MESSAGE

订货型号 Order codes	印记 Marking	封装 Package	无卤素 Halogen Free	包装 Packaging	器件重量 Device Weight
JCS620VT-O-V-N-B	JCS620VT	IPAK	否 NO	条管 Tube	0.35 g(typ)
JCS620RT-O-R-N-B	JCS620RT	DPAK	否 NO	条管 Tube	0.35 g(typ)
JCS620RT-O-R-N-A	JCS620RT	DPAK	否 NO	编带 Brede	0.35 g(typ)
JCS620CT-O-C-N-B	JCS620CT	TO-220C	否 NO	条管 Tube	2.06 g(typ)
JCS620FT-O-F-N-B	JCS620FT	TO-220MF	否 NO	条管 Tube	2.22 g(typ)





绝对最大额定值 ABSOLUTE RATINGS (Tc=25°C)

项 目 Parameter	符 号 Symbol	数 值 Value		单 位 Unit
		JCS620VT/RT/CT	JCS620FT	
最高漏极-源极直流电压 Drain-Source Voltage	V _{DSS}	200		V
连续漏极电流 Drain Current -continuous	I _D T=25°C T=100°C	5	5*	A
		4	4*	A
最大脉冲漏极电流 (注 1) Drain Current -pulse (note 1)	I _{DM}	20	20*	A
最高栅源电压 Gate-Source Voltage	V _{GSS}	±30		V
单脉冲雪崩能量 (注 2) Single Pulsed Avalanche Energy (note 2)	E _{AS}	31.25		mJ
雪崩电流 (注 1) Avalanche Current (note 1)	I _{AR}	5		A
重复雪崩能量 (注 1) Repetitive Avalanche Current (note 1)	E _{AR}	8.3	3.6	mJ
二极管反向恢复最大电压变化速率 (注 3) Peak Diode Recovery dv/dt (note 3)	dv/dt	5		V/ns
耗散功率 Power Dissipation	P _D T _C =25°C -Derate above 25°C	83	36	W
		0.67	0.29	W/°C
最高结温及存储温度 Operating and Storage Temperature Range	T _J , T _{STG}	-55~+150		°C
引线最高焊接温度 Maximum Lead Temperature for Soldering Purposes	T _L	300		°C

*漏极电流由最高结温限制

*Drain current limited by maximum junction temperature





电特性 ELECTRICAL CHARACTERISTIC

项 目 Parameter	符 号 Symbol	测试条件 Tests conditions	最小 Min	典型 Typ	最大 Max	单 位 Units
关态特性 Off –Characteristics						
漏—源击穿电压 Drain-Source Voltage	BV_{DSS}	$I_D=250\mu A, V_{GS}=0V$	200	-	-	V
击穿电压温度特性 Breakdown Voltage Temperature Coefficient	$\Delta BV_{DSS} / \Delta T_J$	$I_D=250\mu A$, referenced to $25^\circ C$	-	0.2	-	V/ $^\circ C$
零栅压下漏极漏电流 Zero Gate Voltage Drain Current	I_{DSS}	$V_{DS}=200V, V_{GS}=0V, T_C=25^\circ C$	-	-	1	μA
		$V_{DS}=160V, T_C=125^\circ C$	-	-	10	μA
正向栅极体漏电流 Gate-body leakage current, forward	I_{GSSF}	$V_{DS}=0V, V_{GS}=30V$	-	-	100	nA
反向栅极体漏电流 Gate-body leakage current, reverse	I_{GSSR}	$V_{DS}=0V, V_{GS}=-30V$	-	-	-100	nA
通态特性 On-Characteristics						
阈值电压 Gate Threshold Voltage	$V_{GS(th)}$	$V_{DS} = V_{GS}, I_D=250\mu A$	2.0	-	4.0	V
静态导通电阻 Static Drain-Source On-Resistance	$R_{DS(ON)}$	$V_{GS} = 10V, I_D=2.5A$	-	0.55	0.8	Ω
正向跨导 Forward Transconductance	g_{fs}	$V_{DS} = 40V, I_D=2.5A$ (note 4)	-	2.4	-	S
动态特性 Dynamic Characteristics						
输入电容 Input capacitance	C_{iss}	$V_{DS}=25V,$ $V_{GS}=0V,$ $f=1.0MHz$	-	216		pF
输出电容 Output capacitance	C_{oss}		-	58		pF
反向传输电容 Reverse transfer capacitance	C_{rss}		-	9.3		pF





电特性 ELECTRICAL CHARACTERISTICS

项 目 Parameter	符 号 Symbol	测试条件 Tests conditions	最小 Min	典型 Typ	最大 Max	单位 Units
开关特性 Switching –Characteristics						
延迟时间 Turn-On delay time	$t_{d(on)}$	$V_{DD}=100V, I_D=5A, R_G=25\Omega$ $V_{GS}=10V$ (note 4, 5)	-	11.5	17	ns
上升时间 Turn-On rise time	t_r		-	23.5	35	ns
延迟时间 Turn-Off delay time	$t_{d(off)}$		-	26.4	40	ns
下降时间 Turn-Off Fall time	t_f		-	10.7	16	ns
栅极电荷总量 Total Gate Charge	Q_g	$V_{DS}=160V,$ $I_D=5A$ $V_{GS}=10V$ (note 4, 5)	-	7.39	10	nC
栅-源电荷 Gate-Source charge	Q_{gs}		-	1.89	-	nC
栅-漏电荷 Gate-Drain charge	Q_{gd}		-	4.19	-	nC
漏-源二极管特性及最大额定值 Drain-Source Diode Characteristics and Maximum Ratings						
正向最大连续电流 Maximum Continuous Drain-Source Diode Forward Current		I_S	-	-	5	A
正向最大脉冲电流 Maximum Pulsed Drain-Source Diode Forward Current		I_{SM}	-	-	20	A
正向最大连续电流 Maximum Continuous Drain-Source Diode Forward Current	V_{SD}	$V_{GS}=0V, I_S=5A$	-		1.4	V
反向恢复时间 Reverse recovery time	t_{rr}	$V_{GS}=0V, I_S=5A$ $di_F/dt=100A/\mu s$ (note 4)		120		ns
反向恢复电荷 Reverse recovery charge	Q_{rr}			430		nC

热特性 THERMAL CHARACTERISTIC

项 目 Parameter	符 号 Symbol	最大值 Value		单 位 Unit
		JCS620VT/RT/CT	JCS620FT	
结到管壳的热阻 Thermal Resistance, Junction to Case	$R_{th(j-c)}$	1.5	3.5	$^{\circ}C/W$
结到环境的热阻 Thermal Resistance, Junction to Ambient	$R_{th(j-A)}$	62.5		$^{\circ}C/W$

注:

- 1: 脉冲宽度由最高结温限制
- 2: $L=2.5mH, I_{AS}=5A, V_{DD}=50V, R_G=25\Omega$, 起始结温 $T_J=25^{\circ}C$
- 3: $I_{SD} \leq 5A, di/dt \leq 200A/\mu s, V_{DD} \leq BV_{DSS}$, 起始结温 $T_J=25^{\circ}C$
- 4: 脉冲测试: 脉冲宽度 $\leq 300\mu s$, 占空比 $\leq 2\%$
- 5: 基本与工作温度无关

Notes:

- 1: Pulse width limited by maximum junction temperature
- 2: $L=2.5mH, I_{AS}=5A, V_{DD}=50V, R_G=25\Omega$, Starting $T_J=25^{\circ}C$
- 3: $I_{SD} \leq 5A, di/dt \leq 200A/\mu s, V_{DD} \leq BV_{DSS}$, Starting $T_J=25^{\circ}C$
- 4: Pulse Test: Pulse Width $\leq 300\mu s$, Duty Cycle $\leq 2\%$
- 5: Essentially independent of operating temperature





特征曲线 ELECTRICAL CHARACTERISTICS (curves)

Typical Output Characteristics, TC = 25 °C

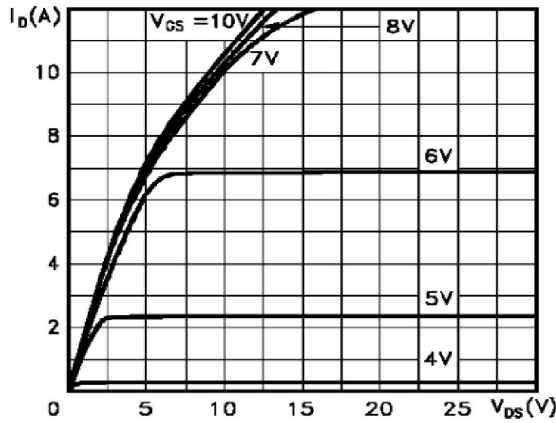

Transfer Characteristics

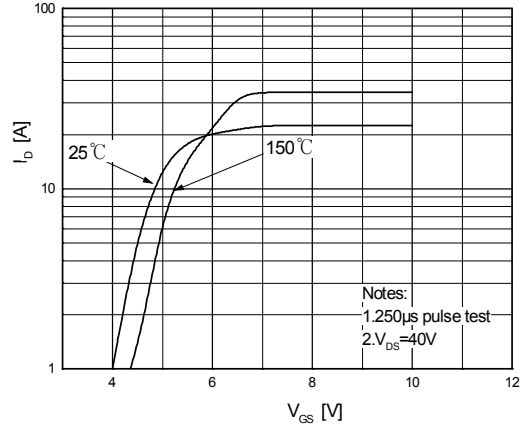

Breakdown Voltage Variation vs. Temperature

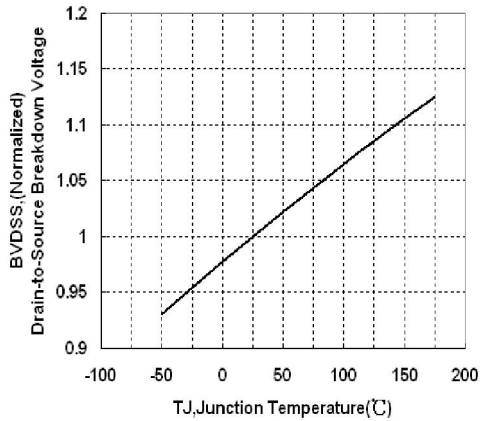

Body Diode Forward Voltage Variation vs. Source Current and Temperature

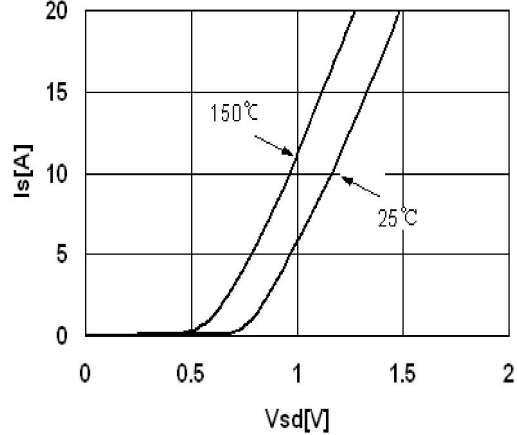

Capacitance Characteristics

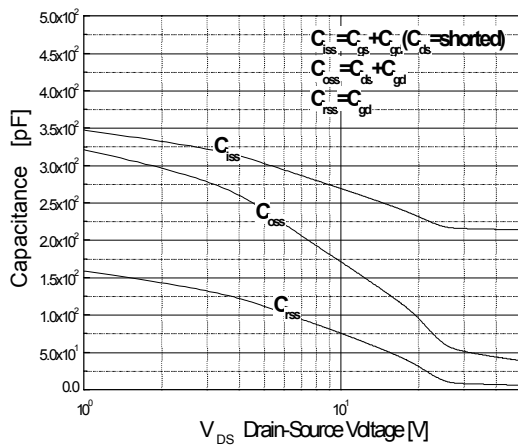

Gate Charge Characteristics

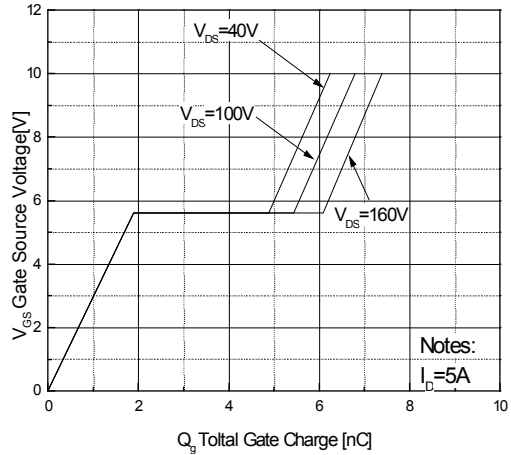



特征曲线 ELECTRICAL CHARACTERISTICS (curves)

On-Resistance Variation vs. Temperature

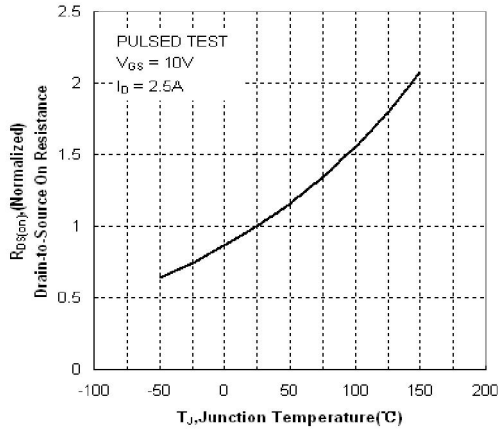

Maximum Drain Current vs. Case Temperature

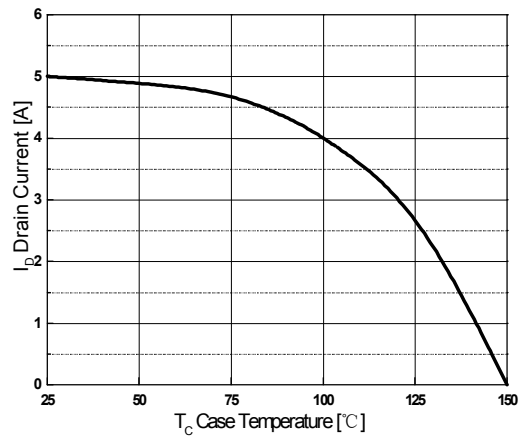

Maximum Safe Operating Area For JCS620CT/VT/RT

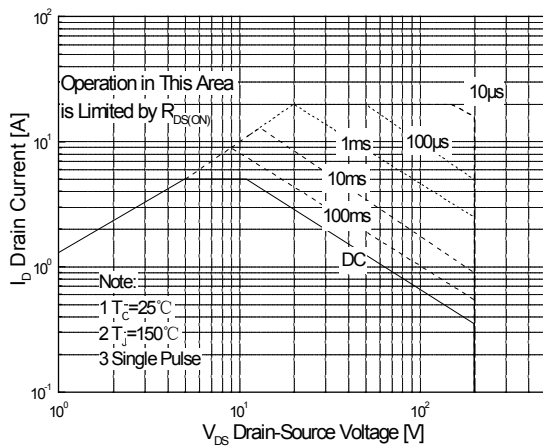

Maximum Safe Operating Area For JCS620FT

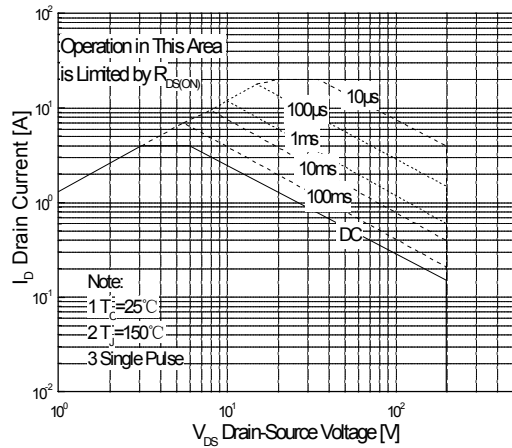



Transient Thermal Response Curve For JCS620CT/VT/RT

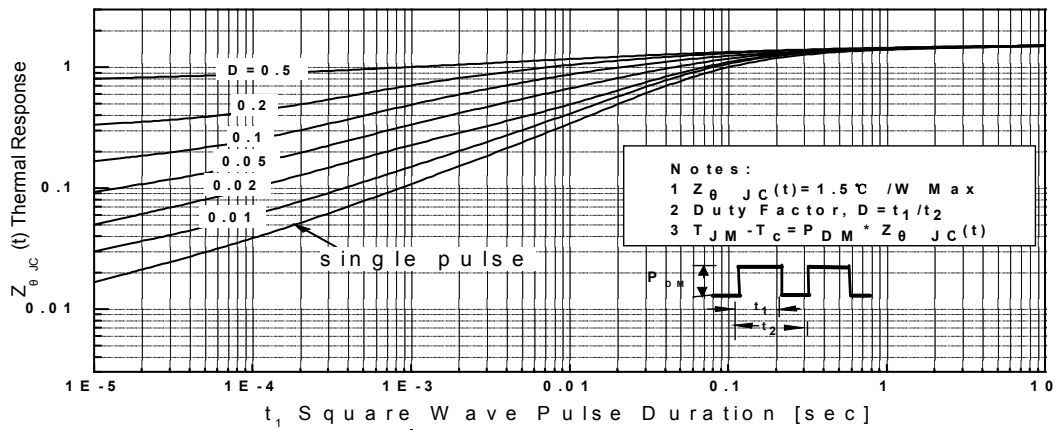

Transient Thermal Response Curve For JCS620FT

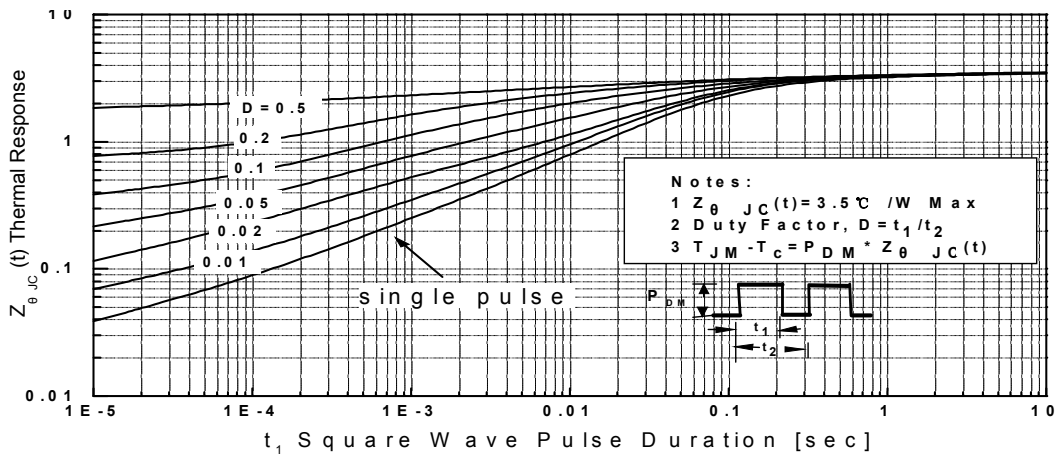



TO-220C

单位 Unit: mm

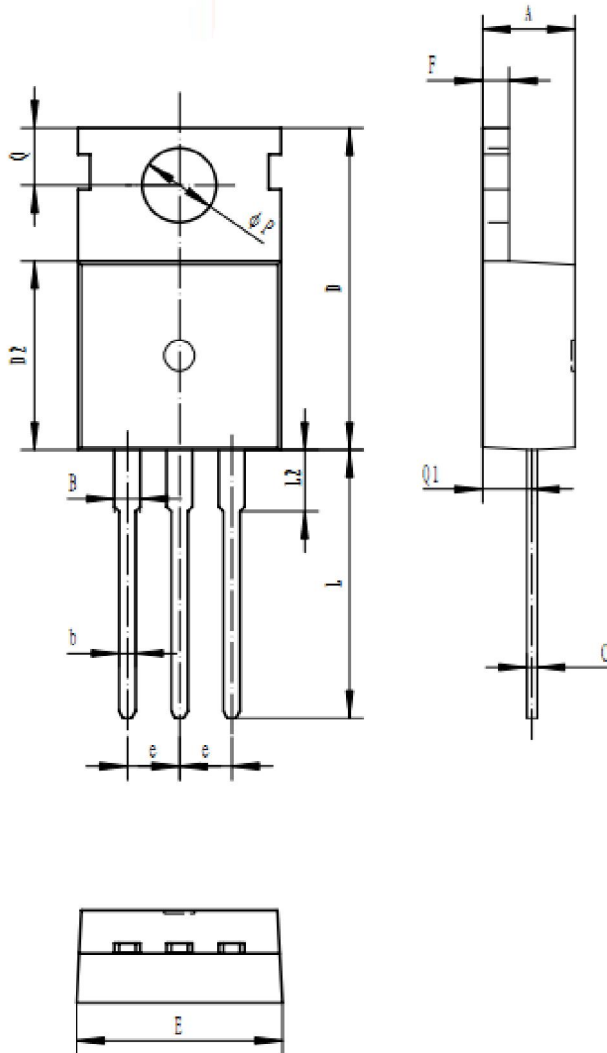

符号 symbol	MIN	MAX
A	4.30	4.70
B	1.22	1.40
b	0.70	0.95
c	0.40	0.65
D	15.20	16.20
D2	9.00	9.40
E	9.70	10.10
e	2.39	2.69
F	1.25	1.40
L	12.60	13.60
L2	2.80	3.20
Q	2.60	3.00
Q1	2.20	2.60
P	3.50	3.80





TO-220MF

单位 Unit: mm

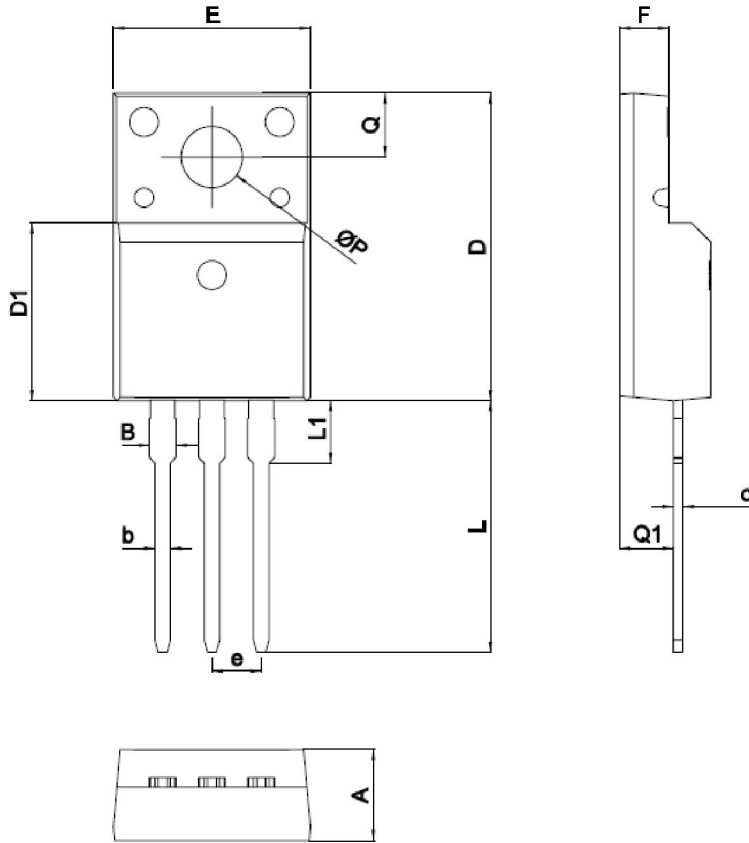

SYMBOL	mm	
	MIN	MAX
A	4.5	4.9
B		1.47
b	0.7	0.9
c	0.45	0.60
D	15.67	16.07
D1	9.04	9.20
e	2.54TYPE	
E	9.96	10.36
F	2.34	2.74
L	12.58	13.38
L1	3.13	3.33
Q	3.2	3.4
Q1	2.56	2.96
ΦP	3.08	3.28





IPAK

单位 Unit: mm

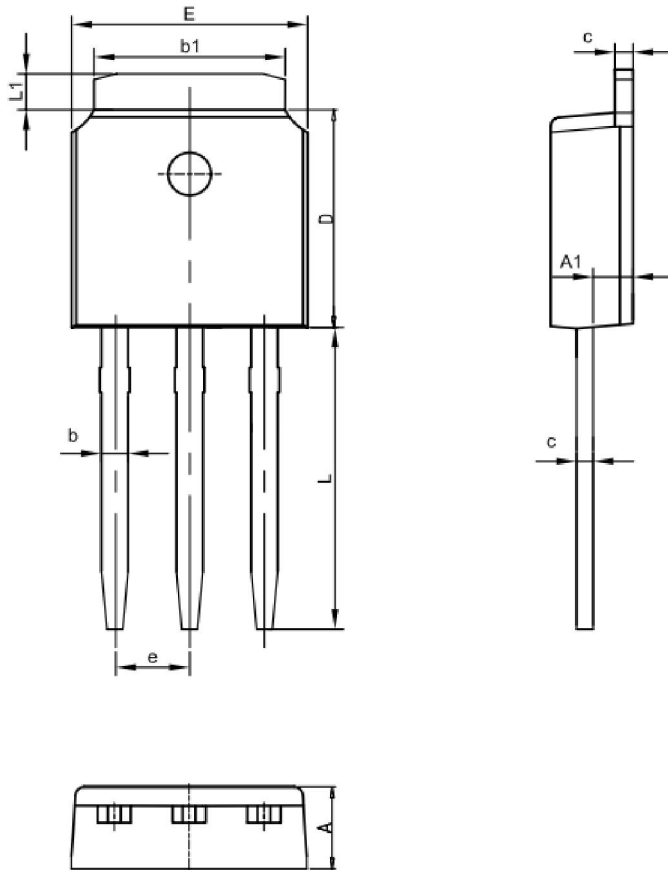

SYMBOL	MM	
	MIN	MAX
A	2.1	2.5
A1	0.87	1.27
b	0.63	0.93
b1	5.13	5.53
c	0.40	0.60
D	5.80	6.40
E	6.30	6.90
L	9.10	9.70
e	2.286BSC	
L1	0.82	1.22





外形尺寸 PACKAGE MECHANICAL DATA

DPAK

单位 Unit: mm

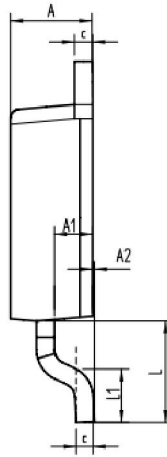
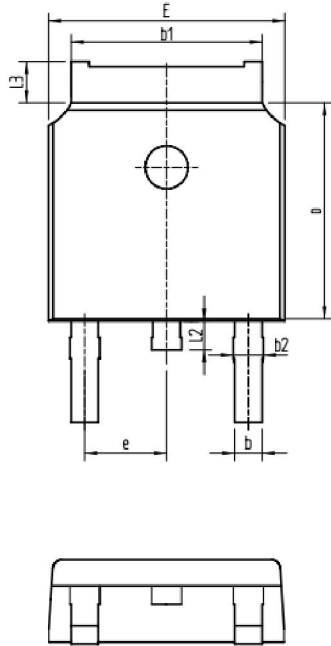

SYMBOL	mm	
	MIN	MAX
A	2.16	2.41
A1	0.97	1.17
A2	0.00	0.15
b	0.63	0.93
b1	5.13	5.53
b2	0.66	0.96
c	0.40	0.60
D	5.80	6.40
E	6.30	6.90
e	2.286BSC	
L	2.50	3.30
L1	1.20	1.80
L2	0.60	1.00
L3	0.85	1.30





联系方式

深圳市日月辰科技有限公司

公司地址：深圳市宝安区松岗街道潭头第二工业城A27栋

邮编：518000

总机：86-755-29556626

手机：86-13113000010

网址：www.szryc.com

CONTACT

SHENZHEN CITY RIYUECHE TECH CO., LTD.

ADD: Songgang shenzhen City, Guangdong Province, China.

Post Code: 518000

Tel: 86-755-29556626

Fax: 86-13113000010

Web Site: www.szryc.com

